

10BX

10-Inch Extended-Range Bass Guitar Speaker

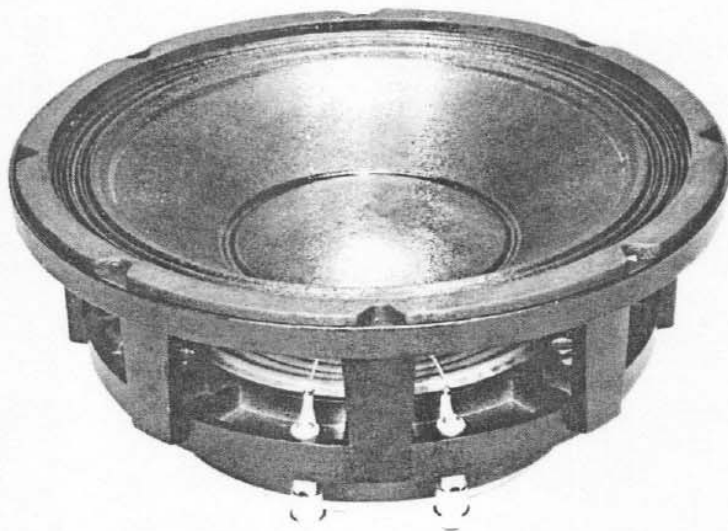

- Modern bass-guitar performance—extended high-frequency response
- Very solid, tight low-frequency response
- Ideal upgrade speaker
- 150 watts long-term power capacity
- Edge-wound flat aluminum wire for maximum output and “bullet proof” reliability
- 98.5-dB sensitivity

SPECIFICATIONS

Usable Frequency Response in a Typical Vented 1.2-Cubic-Foot Enclosure (1 watt/1 meter; see Figure 1):

36-8,000 Hz

Sound Pressure Level (1 watt/1 meter):

98.5 dB

Long-Term Average Power Handling Capacity (per EIA RS-426-A 1980; see Power Handling section):

150 watts

Nominal Impedance:

8 ohms

Voice-Coil Diameter:

63.5 mm (2.5 in.)

Thiele-Small Driver Parameters

f_s (free-air resonance frequency):

63 Hz

Q_{ES} (electromagnetic Q at f_s):

0.342

Q_{MS} (mechanical Q at f_s):

6.5

Q_{TS} (total Q at f_s): $\frac{Q_{ES} Q_{MS}}{Q_{ES} + Q_{MS}}$;

0.325

V_{AS} (volume of air having same acoustic compliance as driver suspension):

42.5 liters (1.5 ft³)

η_0 (half-space reference efficiency):

3.0%

V_D (peak displacement volume of diaphragm: $S_D \times X_{max}$):

0.113 liters (0.004 ft³)

S_D (effective diaphragm area):

0.0004 m² (1.55 in.²)

X_{max} (peak linear displacement of diaphragm):

3.3 mm (0.13 in.)

R_v (dc resistance of voice coil):

5.2 ohms \pm 10%

Mounting Information

(see Installation section),

Mounting Hole Diameter

(eight evenly spaced holes):

7.1 mm (0.28 in.)—letter “L” drill

Bolt Circle Diameter:

244 mm (9.62 in.)

Baffle Opening Diameter

(front or rear mounting):

229 mm (9.0 in.)

Optional Mounting Accessory:

SMH-1 mounting hardware kit

Dimensions (see Figure 2),

Overall Diameter:

259 mm (10.20 in.)

Overall Depth:

110 mm (4.35 in.)

Net Weight:

5.22 kg (11.5 lb)

Shipping Weight:

6.4 kg (14 lb)

DESCRIPTION

The Electro-Voice 10BX is a premium 10-inch speaker designed for bass guitar. This speaker is ideal for the bass guitarist who needs to hear all of the tones and nuances that his four-string bass is capable of producing, at high stage levels. The 10BX is suitable for full-range reproduction of conventional 4-string basses and basses with a “dropped-D” tuning (or low-D extension). Used in multiples, this speaker is capable of thunderous output levels. The 10BX is perfect for the modern bassist who may be incorporating “pop” and “slap” techniques into his/her playing. Power capacity is 150 watts per EIA RS-426-A 1980. The Power-Handling section describes these ratings in detail.

This speaker has been “voiced” specifically for modern bass players. The 8 1/2-lb magnet structure has been newly designed to provide both

high energy and relatively light weight. The overhung voice coil is constructed of a single layer of flat aluminum wire for light weight, low inductance and high efficiency. (Remember, light weight in a speaker’s moving system and high efficiency in the magnet structure generally translate to good high-frequency and transient response.) The most visually obvious difference in these speakers is the cone and dust-dome material. It is a new composite made of paper fibers with mica and epoxy added for remarkable stiffness. The end result is a speaker with a very light-weight moving system and a bright and open sound. Like most professional Electro-Voice speakers, this speaker utilizes an extremely rugged cast aluminum frame to ensure long-term mechanical integrity.

The 10BX may be front- or rear-mounted without an adapter. The optional SMH-1 speaker mounting kit facilitates front mounting (see Installation section).

RECOMMENDED ENCLOSURES

Replacement Use in Existing Enclosures

The 10BX will often be used to replace inferior speakers in existing enclosures. Mechanical and electrical characteristics are such that the superior efficiency, sound quality and reliability of the 10BX will be realized in virtually any sealed or vented (bass reflex) enclosure.

Vented Enclosures

The most extended, lowest distortion and best-controlled bass performance is usually realized in properly designed vented enclosures. In such designs, the vent, or port, actually reproduces the lowest octave or so of bass response. The vent is driven to full acoustic output by a relatively small motion of the speaker cone itself, acting through the air contained within the enclosure. The excursion of the 10BX

10BX SPECIFICATION GRAPHICS

FIGURE 1 — 10BX Frequency Response in Typical Enclosure (vented, 1.2 ft³), 1 Watt/1 Meter

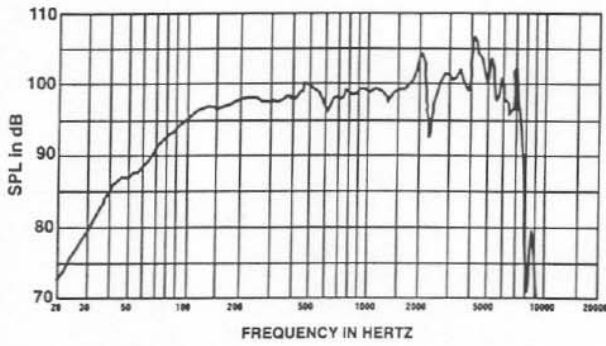

FIGURE 5 — Fillister and Internal Hex Drive Screws for Front Mounting (not to scale)

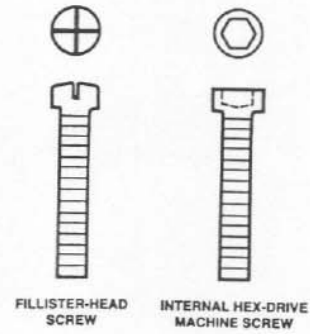

FIGURE 2 — 10BX Dimensions

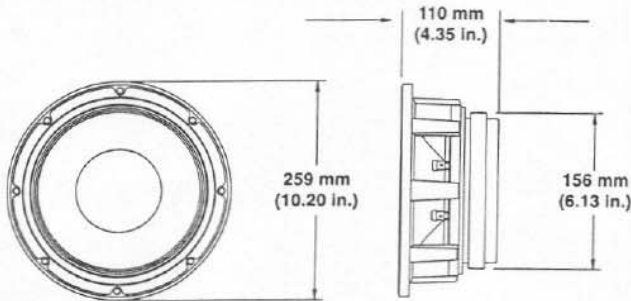

FIGURE 6 — Connection of Two 10BX Speakers in Parallel (net impedance is 4 ohms)

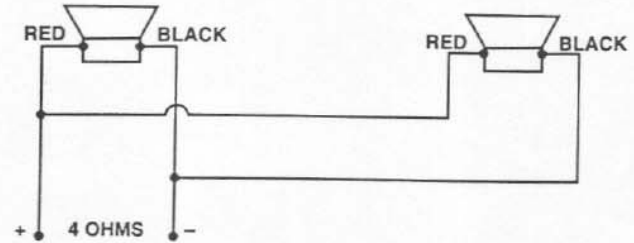

FIGURE 3 — 10BX Front-Mounting Detail (not to scale)

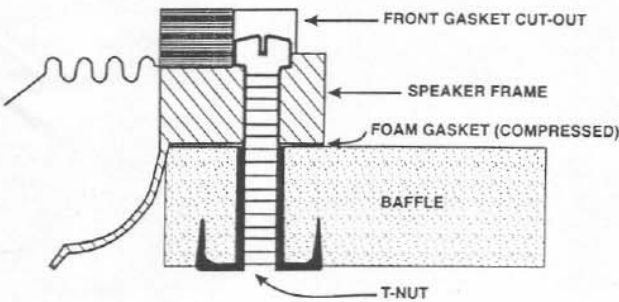

FIGURE 7 — Connection of Two 10BX Speakers in Series (net impedance is 16 ohms)

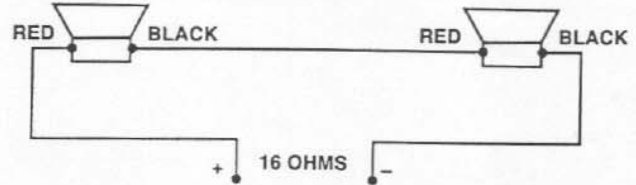

FIGURE 4 — 10BX Rear-Mounting Detail (not to scale)

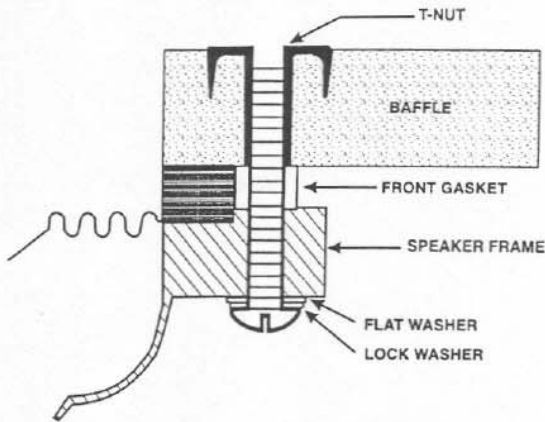
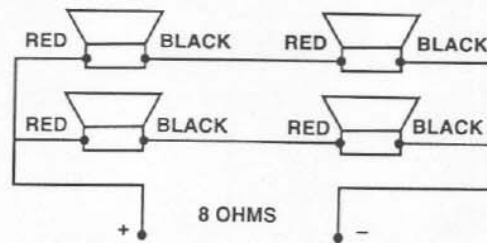

FIGURE 8 — Connection of Four 10BX Speakers in Series/Parallel (net impedance is 8 ohms)



at these frequencies is much reduced compared to sealed or open-backed enclosures, directly reducing harmonic distortion.

Often, in bass guitar systems, a perfectly flat response is not as important as a controlled response. Typical sound-reinforcement systems are "tuned," so the enclosure provides the flattest possible response. Generally, bass-guitar system performance is improved if the enclosure is vented or tuned for roughly the lowest notes that will be played through it. For standard tuning four-string bass, a 44-Hz tuning is recommended. The low "E" on a bass guitar actually vibrates at 41.2 Hz, but a 44-Hz tuning will provide a reasonable amount of vent contribution or additional output at 41.2 Hz. If a four-string bass with a "dropped D" is used, the recommended tuning frequency is 40 Hz. For any of the above examples, the recommended enclosure internal volume is approximately 1.2 cubic feet per speaker. The larger the volume, the less equalization will be required.

INSTALLATION

The 10BX may be front- or rear-mounted, although front mounting is preferred because of convenience. For simple front mounting, the convenient SMH-1 mounting accessory is recommended. Complete mounting instructions for standard front mounting are given below. It is important that recommended baffle openings and mounting hole locations be followed.

Front Mounting

Front mounting requires a 229-mm (9.0-in.) diameter cutout and a 244-mm (9.62-in.) bolt circle. Mark the baffle opening and screw locations on the blank panel first. Drill the screw holes before cutting the large baffle opening. If 1/4-20 screws are used, four screws are sufficient for secure mounting of the speaker. T-nuts are recommended for simple, secure mounting. If T-nuts are used, the holes should be 7.1-mm (0.281-in.) diameter (letter "L" drill). Apply glue to the flanges of 1/4-20 long shank T-nuts before driving into the rear of the holes.

Sealing of the front-mounted speaker is accomplished with the adhesive-backed foam gasket segments that are included with your new 10BX. Strip off the protective paper and apply the gasket to the rear mounting surface of the speaker rim, making certain that the holes in the gasket line up with the mounting holes in the speaker frame.

Length of the 1/4-20 screws should be 1/2-inch plus the panel thickness when using T-nuts. The screws must be fillister head or internal hex drive machine screws to seat down in the recess of the speaker frame gasket (see Figure 3). Screws should be tightened evenly and securely. Maximum torque possible with a proper size screwdriver should be sufficient.

IMPORTANT! When front mounting, the screw head must fit down into the front gasket cutout (see Figure 3).

Rear Mounting

Rear mounting requires the same diameter cutout and screw circle as front mounting. Other comments regarding the use of T-nuts apply to rear mounting as well.

Screw length should be 3/4-inch plus panel thickness if using T-nuts—longer for standard hex nuts. If hex nuts are used, a second nut should be tightened against the first nut to prevent loosening during operation. A lock washer and flat washer are recommended between the screw head and frame (see Figure 4).

Screws should be tightened evenly, but not excessively. Maximum torque possible with a proper size screwdriver should be sufficient. Do not use adhesive-back gasket segments for rear mounting.

Custom Enclosures

If a cabinet is to be constructed from scratch, 3/4-inch solid and jointed or marine plywood is recommended. After construction, be certain interior is completely free of metal filings, wood chips, etc.

Electrical Connections

Use no. 18 or larger stranded wire to connect the two terminals on the loudspeaker to the amplifier output.

FREQUENCY RESPONSE

Frequency response was measured with the 10BX in a 1.2-cubic-foot vented enclosure, tuned to 40 Hz, placed in an anechoic (echoless) environment at 1 meter on axis with a 1-watt swept sine-wave input. The frequency-response curve is shown in Figure 1.

POWER-HANDLING

In musical-instrument systems, unlike sound-reinforcement systems, it is advisable to use speakers that are rated for at least as much power as your amplifier output rating.

To our knowledge, Electro-Voice was the first U.S. manufacturer to develop and publish a power test closely related to real-life conditions. Specifically, the 10BX is designed to withstand the power test described in EIA RS-426-A 1980. The EIA test spectrum is applied for eight hours. This shaped signal is sent to a power amplifier with the continuous power set at 150 watts into the 6 ohm EIA equivalent impedance (30 volts true rms). Amplifier clipping sets instantaneous peaks at 6 dB above the continuous power, or 600 watts peak (60 volts peak). This procedure provides a rigorous test of both thermal and mechanical failure modes.

UNIFORM LIMITED WARRANTY

Electro-Voice products are guaranteed against malfunction due to defects in materials or workmanship for a specified period, as noted in the individual product-line statement(s) below, or in the individual product data sheet or owner's manual, beginning with the date of original purchase. If such malfunction occurs during the specified period, the product will be repaired or replaced (at our option) without charge. The product will be returned to the customer prepaid. Exclusions and Limitations: The Limited Warranty does not apply to: (a) exterior finish or appearance; (b) certain specific items described in the individual product-line statement(s) below, or in the individual product data sheet or owner's manual; (c) malfunction resulting from use or operation of the product other than as specified in the product data sheet or owner's manual; (d) malfunction resulting from misuse or abuse of the product; or (e) malfunction occurring at any time after repairs have been made to the product by anyone other than Electro-Voice or any of its authorized service representatives. **Obtaining Warranty Service:** To obtain warranty service, a customer must deliver the product, prepaid, to Electro-Voice or any of its authorized service representatives together with proof of purchase of the product in the form of a bill of sale or receipted invoice. A list of authorized service representatives is available from Electro-Voice at 600 Cecil Street, Buchanan, MI 49107 (616/695-6831 or 800/234-6831). **Incidental and Consequential Damages Excluded:** Product repair or replacement and return to the customer are the only remedies provided to the customer. Electro-Voice shall not be liable for any incidental or consequential damages including, without limitation, injury to persons or property or loss of use. Some states do not allow the exclusion or limitation of incidental or consequential damages so the above limitation or exclusion may not apply to you. **Other Rights:** This warranty gives you specific legal rights, and you may also have other rights which vary from state to state.

Electro-Voice Speakers and Speaker Systems are guaranteed against malfunction due to defects in materials or workmanship for a period of five (5) years from the date of original purchase. The Limited Warranty does not apply to burned voice coils or malfunctions such as cone and/or coil damage resulting from improperly designed enclosures. Electro-Voice active electronics associated with the speaker systems are guaranteed for three (3) years from the date of original purchase. Additional details are included in the Uniform Limited Warranty statement.

Service and repair address for this product: Electro-Voice, Inc., 600 Cecil Street, Buchanan, Michigan 49107 (616/695-6831 or 800/234-6831).

Specifications subject to change without notice.